

Rockfon[®] Planostile[™] D

Features & Benefits

- Lay-in metal panels with deep reveal and recess options for interior, grid-based suspension installations
- Range of recessed and reveal panel depths available
- Acoustical performance options available

Applications

- Conference Rooms
- Lobbies
- Airport Terminals
- Transit Facilities
- Retail

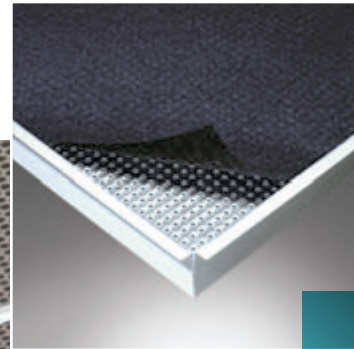

Rockfon® Planostile™ D

LEED® V4 HIGHLIGHTS

Materials and Resources (MR)

- Waste Management Planning ✓
- Interiors Life Cycle Impact Reduction ✓
- Environmental Product Declarations ✓
- Sourcing of Raw Materials ✓
- Material Ingredients -
- Waste Management ✓

Indoor Environmental Quality (EQ)

- Low-Emitting Materials ✓
- Interior Lighting -
- Acoustic Performance ✓

Recycled Content: up to 85%

Product Code Example: **252588:PLST:PLAD:DO3:24x24:E:01:.40AL**

Edge Type: Depth (D) Reveal Edge (3") Dimensions: 24" x 24" Color: Material: White 0.040" Aluminum



252588:PLST: PLAD: DO3: 24x24: E: 01: .40AL

Family Number & Name:
252588 Planostile™
Metal Panel

Reveal Type:
Downward 3" Depth

Perforation:
20.8% Open Area

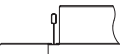
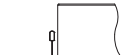

Family Number & Name	Edge Type	Reveal Type	Dimensions	Perforations* (% open area)	Material	NRC	Fire Class	Light Reflectance	Low VOC
252588:PLST: Planostile™ Metal Panel	PLAD: Depth (D) Reveal Edge (1") 	1" Reveal Depths: UP1: Upward 1" Depth DO1: Downward 1" Depth	24x24: 24" x 24" CUST: **	Solid: 0% E: 20.8% V: 4.9%	.40AL: 0.040" Aluminum	up to 0.90***	A	-	✓
	PLAD: Depth (D) Reveal Edge (2") 	2" Reveal Depths: UP2: Upward 2" Depth DO2: Downward 2" Depth							
	PLAD: Depth (D) Reveal Edge (3") 	3" Reveal Depths: UP3: Upward 3" Depth DO3: Downward 3" Depth							
	PLAD: Depth (D) Reveal Edge (4") 	4" Reveal Depths: UP4: Upward 4" Depth DO4: Downward 4" Depth							

* For graphic representations of the perforation options, see the Rockfon Perforations Brochure.

** For designer specified dimensions, contact Rockfon Technical Services at 1-800-323-7164 or techservices@rockfon.com.

*** NRC values are dependent on perforation patterns, plenum depth and acoustical backer options. Contact Rockfon Technical Services for more information at 1-800-323-7164 or techservices@rockfon.com..

Note: This system is not approved for exterior use.

Choose from the above product options to build your product code

Family Number & Name	Edge Type	Reveal Type	Dimensions	Perforation	Color*	Material
252588:PLST:	PLAD:					.40AL

* Select one of our many color options, located on page 3

Standard colors:



01 White



08 Black



44 Satin Silver



888
Winchester
Grey

Premium colors:



Color-all



Custom
(color match)

Metallic colors:



795
Champagne
Metallic

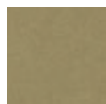

796
Beige
Metallic



797
Iron Glimmer
Metallic



798
Copper
Metallic

Metalwood® Woodgrain Finishes:
(Shown for reference only - See footnote**)



650R
Maple**



651R
Cherry**



652R
Pumpkin
Maple**



653R Oak**



654R Karri**



655R
Bamboo**



656R
Walnut**



401 Maple*



402 Oak*



403 Cherry*



404 Pumpkin
Maple*



405 Karri*



406 Walnut*

Woodscenes® Painted Finishes†:



800
Lazy Maple



801
Aged Teak



803
Burnished
Cherry



804
Sleek Cherry



805
Weathered Oak



806
Barnwood
Grey

* Coordinating solid color to match Metalwood Woodgrain Finishes.

** Metalwood Woodgrain Finishes not available for Rockfon Infinity™ and Planostile D; use coordinating solid color. See footnote *.

† Woodscenes Painted Finishes are a decorative powder coat finish that replicate real wood; variations in color and pattern will occur.

Note:

- Woodscenes grain direction is parallel to the length of the panel.
- See rockfon.com for more information on color options.

Colors shown are reproduced as close as possible to actual product color within the limitations of printing technology. Color chips are available upon request and should be reviewed before making a final selection. Variations in color matches of system components to ceiling panels can result from slight differences in texture, room lighting, painting process and subjectivity of observers.

Planostile D Suspension

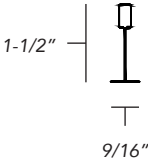
Detail	Product Number	Duty Rating	Length	Slotting	Spacing	Finish
	Main Runner*					
	10.04.000	Intermediate Duty (ID)	144"	6" O.C.	48" O.C. Standard***	see footnote **
	10.04.040	Heavy Duty (HD)				
	Cross-Tee (Stab-in)*					
	10.04.014	NA ¹	48"	16" O.C.	48" O.C. Standard***	see footnote **
	10.04.022		24"	-		

* Suspension system for Planostile based on Chicago Metallic® Ceiling Suspension. Reference ICC-ES Evaluation Report ESR-2631 for testing information.

** Available in Standard, Premium, Metallic and Woodscenes finishes.

*** Custom suspension spacing available. Contact Rockfon Technical Services at 1-800-323-7164 or techservices@rockfon.com.

¹ Not Applicable - Duty rating applies only to main runners with a 4-ft span.

Note:

- For seismic installations refer to Rockfon Seismic Ceiling Suspension Guide.

Planostile D Perimeter Trim

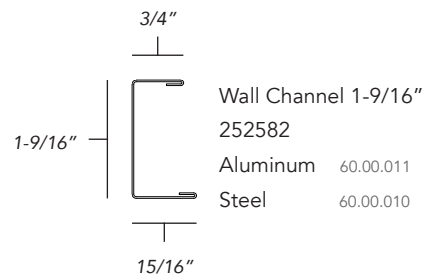
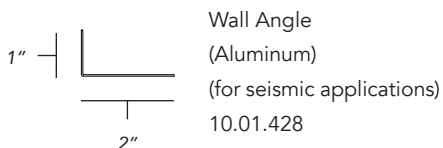
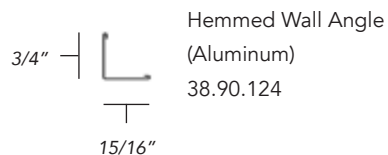

Note - Wall Angle and Wall Channel:
 - Standard, Premium, Metallic and Woodscenes finishes available.
 - Reflective and anodized finishes available - one side only.

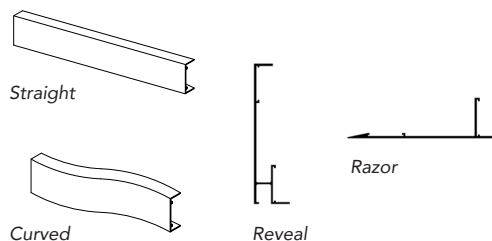

Perimeter Trim
 (Rockfon Infinity)
 (see Infinity data sheet)
 Infinity Engineered Straight Profile
 Infinity Engineered Curved Profile
 Infinity Standard Straight Profile
 Infinity R (Reveal) Edge Profile
 Infinity Z (Razor) Edge Profile

Note:
 - See Infinity Data Sheet for finish options.
 - For Infinity Trim and Planostile D detail solutions,
 contact Rockfon Technical Services at 1-800-323-7164
 or techservices@rockfon.com.

Planostile D System Accessories



Hold Down Insert
(for Wall Channel 1-9/16")
(1-1/2" height; 3/4" faces)

Aluminum

11" length 249674
60.00.013

22" length 249675
60.00.015

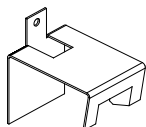

Perimeter Clip
(Galvanized)

251952
1499.00

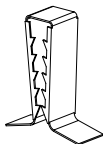

Hold Down Clip
(Metal - Black Oxide)
264683
63.26.200

Note:

- For Planostile Lay-in panels
- For panels with minimum open area

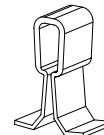

Hold Down Clip
(Clear Plastic)
250382
8886.00

Note:

- For Planostile Lay-in panels
- For panels with maximum open area

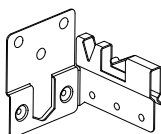

Seismic Perimeter Clip
(for seismic installations)

(Galvanized)
250374
1496.00

Note:

- See *Seismic Ceiling Suspension Guide* for more information.

Planostile D Standard Details

Wall Angle

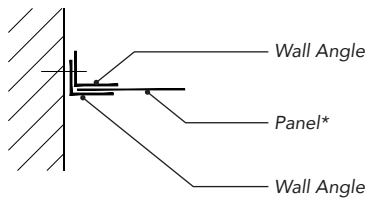

Wall Channel

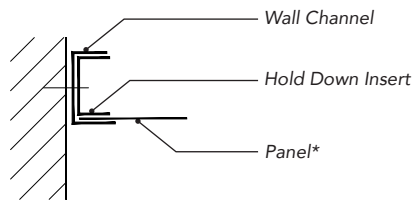

* Planostile Lay-in Square Edge or Reveal Edge panels are recommended for the perimeter of a Planostile D ceiling installation. For more information contact Rockfon Technical Services at 1-800-323-7164 or techservices@rockfon.com.

Rockfon Infinity Perimeter Trim with Lay-in Square Edge Panel

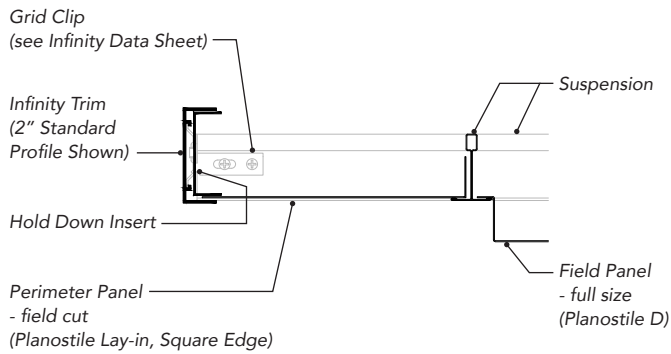

Rockfon Infinity Perimeter Trim with Lay-in Reveal Edge Panel

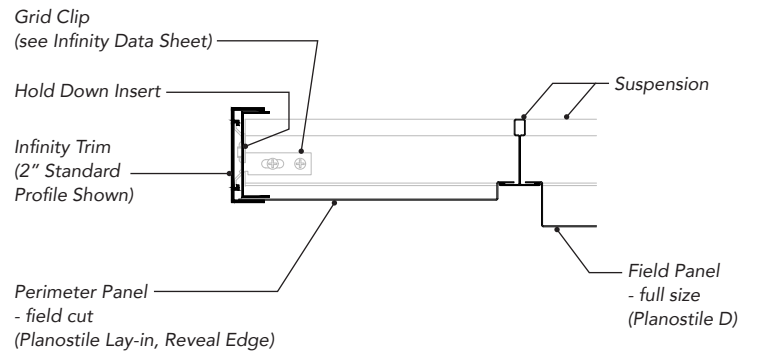

Planostile D System Detail

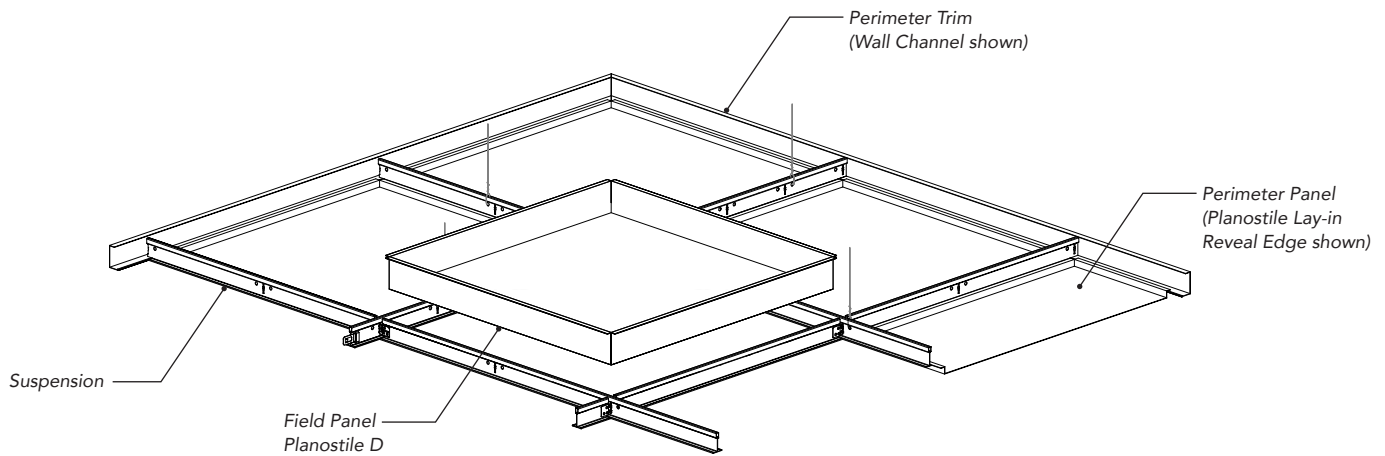

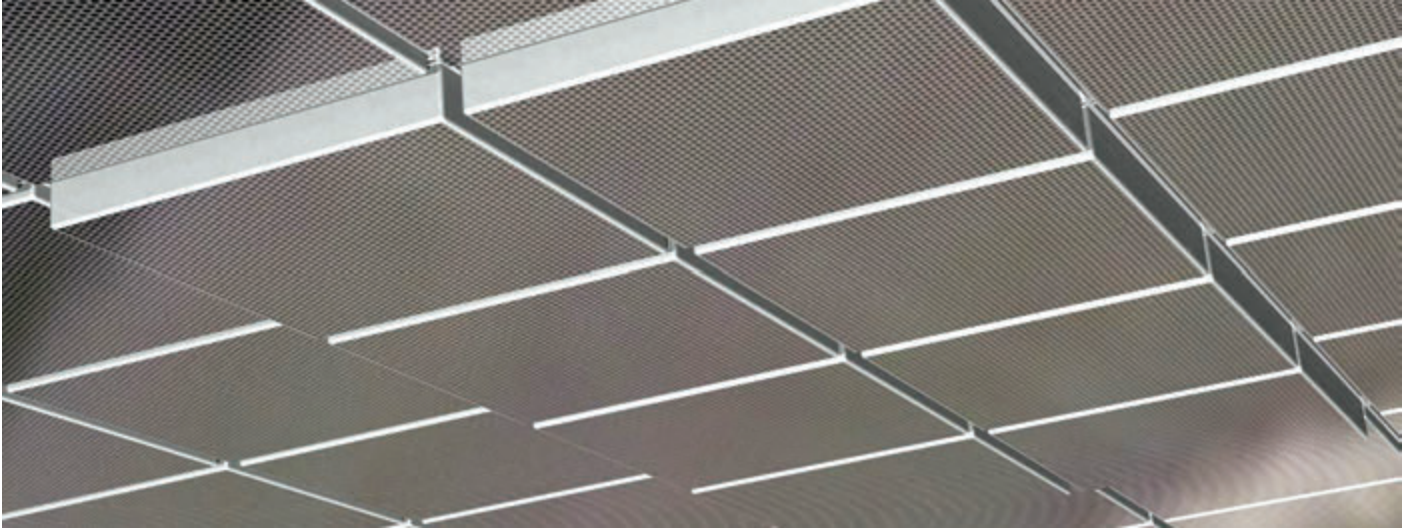

Material

0.040" Aluminum



Fire Performance

Surface burning characteristics:
UL723 (ASTM E84)
Flame Spread Index: 0
Smoke Developed Index
(UL Labeled): 0



Hygiene

Metal provides no sustenance
to microorganisms



Warranty

1-Year Limited
Product Warranty.
See rockfon.com



Environment

- Up to 85% recycled content
- 100% locally recyclable



Cleaning

- Damp Cloth

080819

Rockfon

4849 S. Austin Ave.
Chicago, IL 60638 USA